

Technical Overview

G3 Digital Cutter

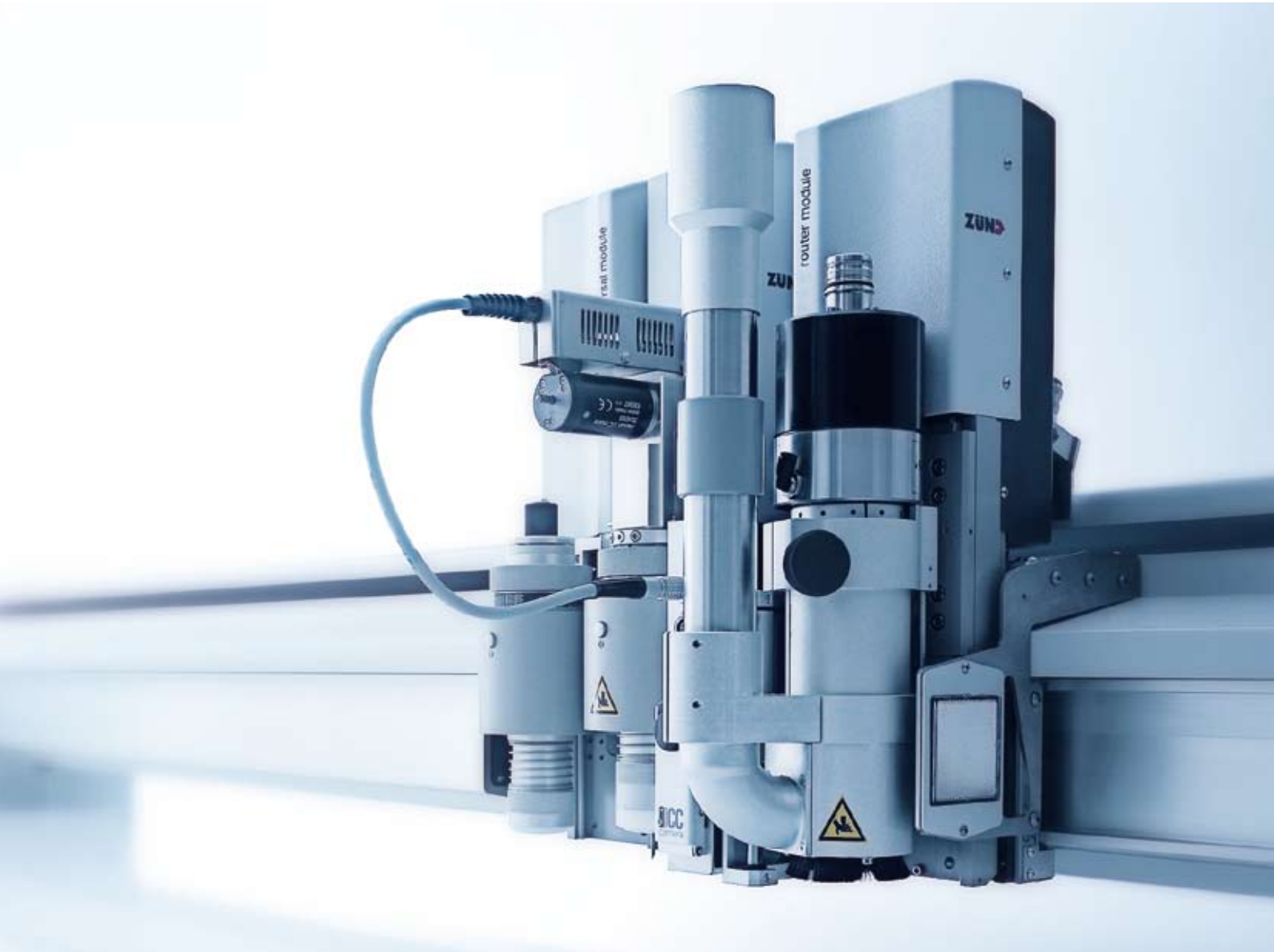

Advanced flatbed cutter/router
for maximum productivity.

The modular cutter concept.

Intelligent, efficient, ready for the future.

G3 is modular in many ways, and not only in terms of construction, basic and optional equipment. It is equally modular as integral component of your production department. G3 is capable of adapting seamlessly to changes in your cutting requirements. The benefits to you: knowing that your ROI is guaranteed – now and in the future.

Complete modularity

Freely combine up to 3 modules. Module and tool changes are quick and easy, keeping change-over times to a minimum. In applications that require processing preprinted graphics, the laser pointer or optional ICC camera facilitate perfect registration.

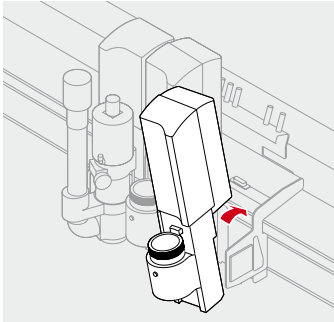

Attach modules in seconds while the machine is running.

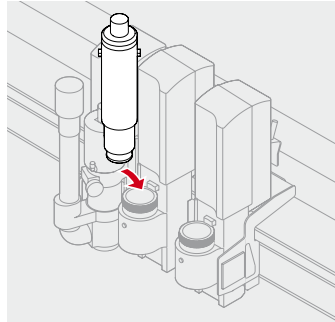

The universal module accommodates all tools.

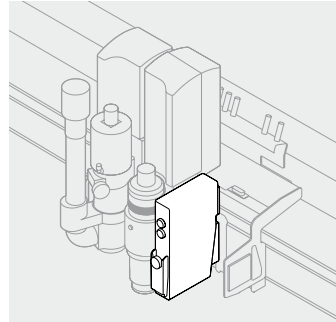

The ICC camera works with all tools and modules.

One machine, many functions

Equipped with different modules, one machine becomes a multifunctional production system. Since tools and modules can be added any time, upgrades are easy and cost-effective.

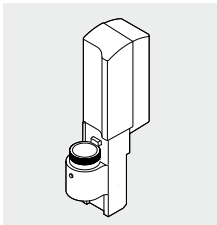

Universal module
Accommodates all tools.

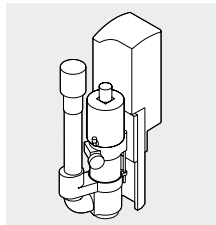

1 kW router module
With integrated automatic dust extraction.

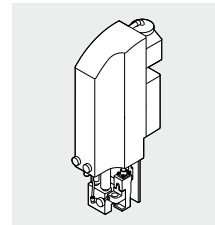

Punching/ notching module
Punches up to 10 holes per second.

Tools for every application

All tools shown here can be inserted into the universal module. So all you need is one machine, one module, and the appropriate tool for any material and application.

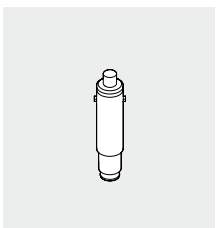

Universal cutting tool

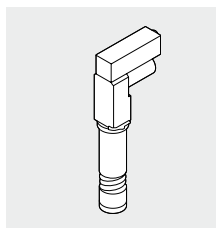

Oscillating cutting tool (electric) for materials up to 26 mm / 1"

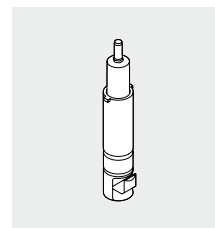

45° Bevel-cut tool for materials up to 5 mm / 3/16"

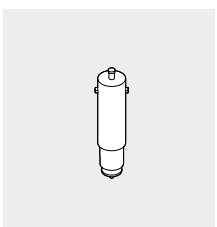

Kiss-cutting tool

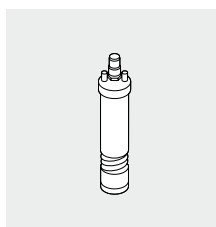

Oscillating cutting tool (pneumatic) for materials up to 50 mm / 2"

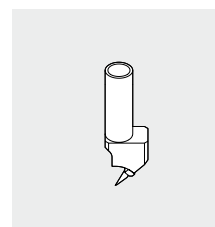

V-cut tool with 0°, 15°, 22.5°, 30°, 45° cut angles for materials up to 16 mm / 5/8"

Well thought out – from start to finish.

Right from the start, G3 sets new standards: for example, with the standard 60 mm / 2.36" clearance for processing materials up to 50 mm / 2" thick. Or with the automatically controlled vacuum from 1 to 9 kW (optional up to 15 kW). It lets the machine generate just the right amount of vacuum for any given task, reducing energy consumption and operating cost. Or with the advanced safety system, including light barriers and 4 emergency stops. These are just a few of the valuable features, including a 2-year warranty on the base machine, that make G3 exceptional.



Tool setup

G3 makes initializing tools automatic, simple, and foolproof, eliminating the potential for cutting too deep.

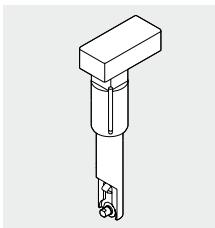

Driven rotary tool
for textile and
fibrous materials

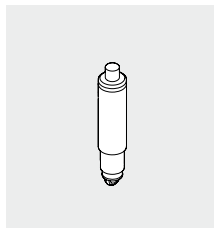

Creasing tool type 2
for carton and
plastics

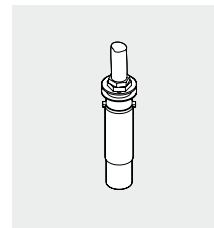

Inkjet marking
system*

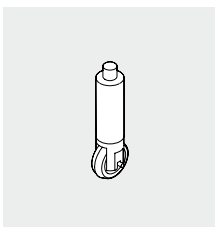

Creasing tool type 1
for corrugated
cardboard

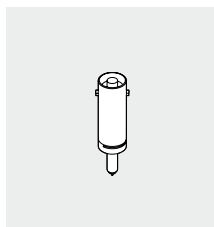

Universal
drawing tool

* Available on request

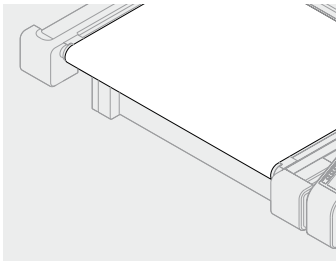

Material transport

For rolled materials and jobs longer than the table. The conveyor belt serves simultaneously as cutting underlay and support during advances.

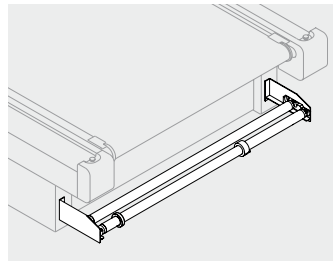

Universal roll-off unit

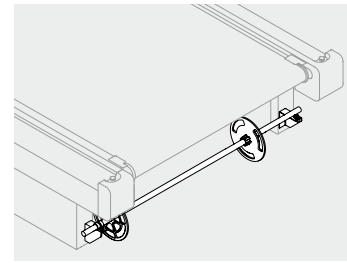

Roll-off unit with shaft

Work area

M

L

XL

2XL

3XL

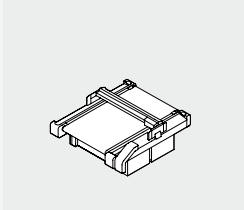

G3 M-1600
1330 x 1600 mm
52" x 63"

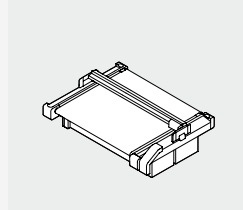

G3 XL-1600
2270 x 1600 mm
89" x 63"

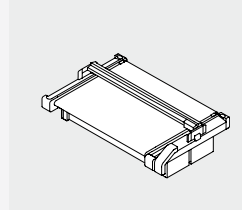

G3 2XL-1600
2740 x 1600 mm
107" x 63"

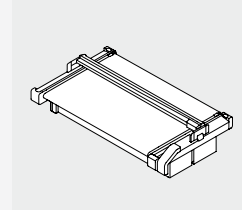

G3 3XL-1600
3210 x 1600 mm
126" x 63"

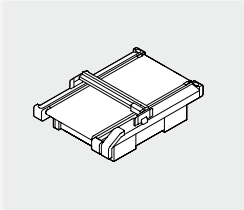

G3 M-2500
1330 x 2500 mm
52" x 98"

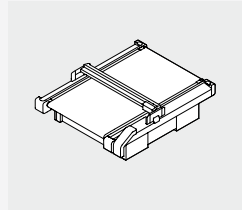

G3 L-2500
1800 x 2500 mm
70" x 98"

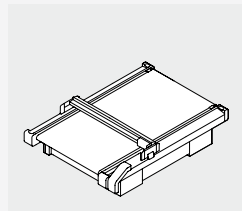

G3 L-3200
1800 x 3200 mm
70" x 125"

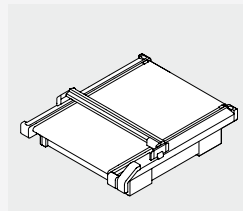

G3 XL-3200
2270 x 3200 mm
89" x 125"

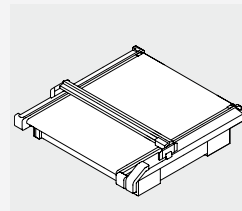

G3 2XL-3200
2740 x 3200 mm
107" x 125"

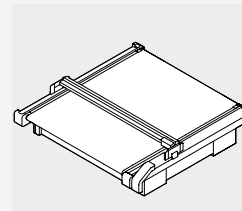

G3 3XL-3200
3210 x 3200 mm
126" x 125"

Workstation

Integrated workstation for PC, monitor, keyboard, and space for tool storage.

Cutter extensions

Cutter extensions provide efficient material loading/unloading during cutting operations. Available are extensions in half or full table sizes, which can be added to the front or back of the machine.

Sheetfeeder

Reliably delivers sheets from stack to cutter. Equipped with a sheetfeeder, G3 becomes a fully automated production machine for sheet/board stock.

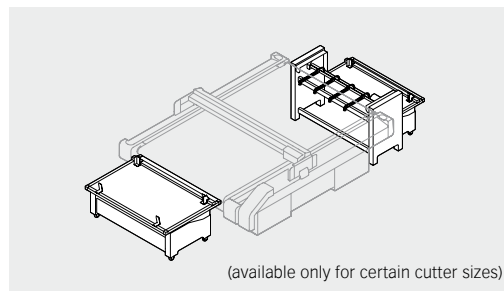
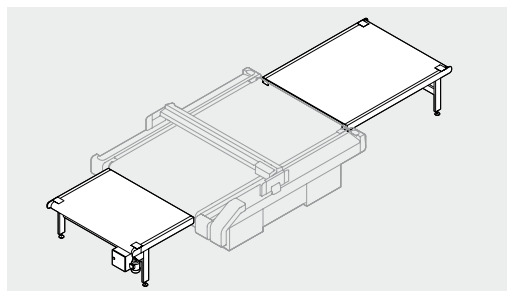

(available only for certain cutter sizes)

Verkürzung = 15 mm

Solid reasons for Zünd G3.



Production made profitable.

Zünd G3 eliminates the bottlenecks in your finishing department by automating all cutting/trimming functions. Manual cutting, with all inherent costs, potential for mistakes, and lack of efficiency, is reduced to an absolute minimum. With optimized workflow, G3 further boosts productivity.



Versatility and longevity.

No other cutting or routing machine is as flexible or adaptable as G3 with its modular tool concept. G3 cuts materials up to 50 mm / 2" thickness. The selection of sizes, modules, tools, and material-handling options is extensive yet straightforward.



Swiss workmanship, quality, reliability.

G3 cutters from Zünd are specifically designed for 24/7 operation. They offer a unique combination of heavy-duty construction and superb accuracy. The standard 2-year manufacturer's warranty on the base machine is further evidence of G3's exceptional quality.



Ergonomics and user-friendliness.

Designed by award-winning industrial designer Richard Amiel, G3 provides optimal workflow efficiency with such timesaving features as uninhibited access from all sides, an ergonomically designed control panel, and 60 mm / 2.36" clearance between beam and cutting surface.



Safety and eco-friendliness.

With G3, Zünd has made a conscious effort to set new standards in safety and concern for the environment. All G3 safety features are standard equipment. An integrated variable vacuum system keeps both cost and energy consumption to a minimum.



The Best from the Global Market Leader.

G3 is not only a product of celebrated Swiss workmanship but also of Zünd's 20 years of innovative digital cutter development and 13,000 installations worldwide. With this latest generation, Zünd as global market leader has developed the world's most advanced cutting/routing system.

Verkürzung = 15 mm

A good reputation with good reason.

Performing a cut above.

As family-owned business based in Altstätten, Switzerland, Zünd Systemtechnik AG has been the leading developer of digital cutting technologies for more than 20 years. Zünd epitomizes Swiss quality in machine construction and engineering and has for years been synonymous with precision, performance, and reliability. It is no wonder Zünd has more flatbed cutters installed worldwide than any other supplier.



Worldwide distribution and service.

Zünd and its worldwide network of distributors and service partners excel in providing customer proximity, expert before- and after-sales support, and uncompromising service. All service technicians at our subsidiaries in Hong Kong and the USA, as well as many of our partners' technicians in more than 40 countries, are trained and certified at the factory in Switzerland. Service hotlines worldwide ensure continual customer support and maximum machine uptime.

Headquarter
Zünd Systemtechnik AG
Industriestrasse 8
CH-9450 Altstätten
T +41 71 757 81 00
F +41 71 757 81 11
info@zund.com
www.zund.com

ZÜND
swiss cutting systems